

Termination Load

Technology Manual

1. **Model:** BC-TE05-01

2. **Product Name:** RF Termination Load

3. Description:

Frequency	DC~3GHz
Connector	N-male
VSWR	≤ 1.2
Power	5W
Impedance	50 Ω
Temperature Range	-55 $^{\circ}$ C ~ +125 $^{\circ}$ C

4. Picture :

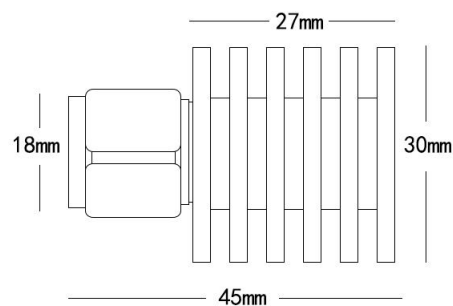

Tolerance : $\pm 2\%$