

Attenuator

Technology Manual

1. **Model:** BC-AT50-02

2. **Product Name:** RF Coaxial Attenuator

3. **Description :**

Frequency	DC~3GHz/4GHz
Connector	N-JK
VSWR	≤ 1.2
Power	50W
Impedance	50 Ω
Attenuation value	1-50dB
Attenuation	1, 3, 5, 6, 10, 15, 20, 30, 40, 50dB is available 1-10dB ± 0.5 dB, 15-30dB ± 1 dB, 40-50dB ± 1.5 dB
Temperature Range	-55 $^{\circ}$ C ~ +125 $^{\circ}$ C

4. **Picture :**

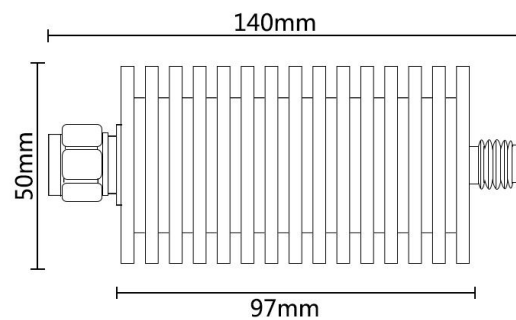

Tolerance : $\pm 2\%$