

Attenuator

Technology Manual

1. **Model:** BC-AT50-01

2. **Product Name:** RF Coaxial Attenuator

3. **Description:**

Frequency	DC~3GHz/4GHz
Connector	N-JK
VSWR	≤ 1.2
Power	50W
Impedance	50 Ω
Attenuation value	1-40dB
Attenuation	1, 3, 5, 6, 10, 15, 20, 30dB is available 1-10dB. ± 0.5 dB, 15-40dB ± 1 dB
Temperature Range	-55 $^{\circ}$ C ~ +125 $^{\circ}$ C

4. **Picture :**

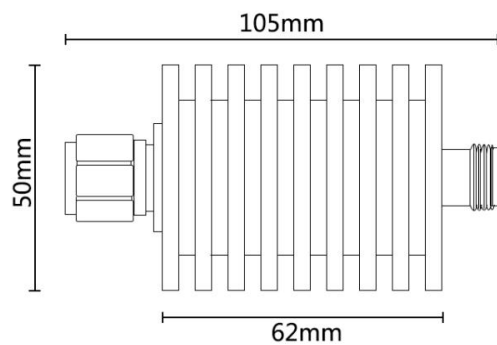

Tolerance : $\pm 2\%$